

SmartROC C50

Surface drill rig for quarrying, mining and construction

Hole diameter: 90–140 mm (3.5– 5.5")



Speed, power and precision

The SmartROC C50 from Epiroc gives you the best of both worlds. The rig combines high penetration rates with superior hole quality – even in the most challenging conditions.

The outstanding precision of the COPROD system provides you with optimal blasting results, increased

safety and a sustainable outcome in the whole quarrying and surface mining operation.

4.5 meter COPROD sections minimize rod handling time.

Fewer hoses and couplings makes maintenance easier.

+ Main benefits

The superior precision in the drilling gives you optimal blasting results, increased safety and quality throughout the whole operation.

The low fuel consumption, the low amount of energy loss and the long service life reduces your total running cost.

SmartROC rigs deliver – shift after shift. We know what is important to you in the end: productivity and profitability.

A fully-automated drill cycle reaches the desired hole depth whilst adding and extracting rods automatically.



Regular servicing from an Epiroc technician will safeguard your investment and keep availability and productivity high.



Smart features such as Hole Navigation System (HNS) helps you make smart decisions that improve your entire operation.



The quiet, air-conditioned safety cabin is ROPS and FOPS-approved. A happy operator means better productivity.



Discover more about the SmartROC C50.

Progressive drilling control especially for COPROD.

The SmartROC C50 is equipped with the powerful, enduring and well-proven 3060CR rock drill.

Ergonomic cabin which offers excellent visibility and low noise levels.

Efficient hydraulic system which utilizes a small hydraulic tank and short hoses which makes for easy troubleshooting.



6th Sense
Smart. Safe. Seamless.

SmartROC C50 is a 6th Sense product.

6th Sense is the Epiroc way of optimizing your value chain through automation, system integration and information management.



Scan to read more about 6th Sense

Safety, efficiency and productivity are built into every single detail

The SmartROC C50 is designed to perform. It is one of the fastest, safest and most efficient drill rigs available on the market today. Featuring unique and well-proven COPROD technology, the SmartROC C50 delivers – even under the most demanding conditions.



+ Superior hole quality with COPROD

With COPROD drill strings you can select the most efficient drill rod outer diameter. SmartROC functions enable you to adapt the water flushing capability to match the selected hole diameter and not risk destroying the hole walls by over-flushing or getting stuck due to low flushing. The smooth joints of the COPROD drill string means the flushing air speed is the same from the bottom to the top of the hole – this means totally straight and smooth hole walls. By adapting the flushing, fuel is saved and the life of consumable items is increased.



+ Plan your work then implement your plan

The SmartROC C50 gives you complete control. The drill cycle is fully automated to ensure drilling goes as planned. Rods are added and extracted automatically to reach the desired depth. This provides consistency to the operation and the rig is less dependent on the operator. Auto feed alignment ensures that the desired angle is maintained during drilling – crucial for optimum blasting results. The SmartROC C50 delivers results you can count on – shift after shift.



+ ROC Manager and HNS help maximize your processes

The user-friendly ROC Manager office software makes it easy to plan the blast to get the best outcome. It provides you with outstanding information to assist with the planning and controlling of your operations. In conjunction with our optional Hole Navigation System (HNS), it enables you to plan the next bench easily, and then quickly make it available for the rig. The rig reports back to you in the form of log files. Having the right data and information at your finger-tips, helps you make smart decisions that improve your entire quarrying or mining process.



A comprehensive service offering

Even the best equipment needs to be serviced regularly to make sure it sustains peak performance. An Epiroc service solution offers peace of mind, maximizing availability and performance throughout the lifetime of your equipment. We focus on safety, productivity and reliability.

By combining genuine parts and an Epiroc service from our certified technicians, we safeguard your productivity – wherever you are.

The secret of COPROD

Compared to traditional drilling methods, our COPROD system has a longer service life. It's also the most efficient way to transfer energy, as the unique dual string design allows more power to be transferred to the drill bit through the jointless inner rods.

Inside each rigid, threaded pipe section is an impact rod furnished with stop lugs to keep it in place. The COPROD sections are joined together via the drill pipes.

The drill pipes only transmit rotation force. All the negative effects from transmission of impact energy through the threads is entirely eliminated. The result? High impact power with minimal wear.

The outer pipes are smooth and flush along the entire length of the drill string. This means it's almost impossible for jamming to occur. The unique design of the COPROD head eliminates the rod guide and reduces air passage in the bit spline area to an absolute minimum. This prevents shank breakage, while the improved airflow reduces clogging in the bit. The drill bit is made of a new grade of steel with high impact and fatigue strength. In combination with the system's low air pressure (12 bar), less airflow in the annulus space results in up to 50% longer life.

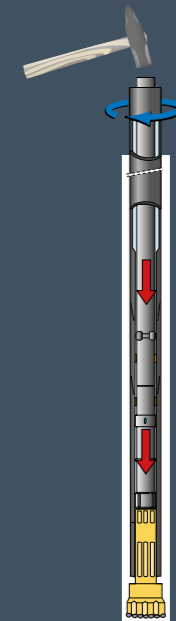

Technical specifications

Main components

- Crawler type two speed undercarriage with track oscillation system
- Caterpillar turbo charged diesel engines
- Atlas Copco screw type compressor
- Hydraulic cooling system for 50 °C ambient temperature
- Warning sound and flashing light
- Fixed boom system
- Hydraulic chain feed system with hose guide
- Hydraulic rock drill/COP 3060CR
- Rock drill lubrication system
- Progressive COP Logic
- Toe-hole drilling system
- Carousel type rod handling system
- Hydraulic breakout table with double drill steel support and movable dust collector hood
- Double hose drum
- Dust Collection System (DCT)

Safety cabin

- ROPS and FOPS-approved with rubber vibration dampers
- 2 x wipers with washer
- Rear view mirrors
- Clear laminated glass (front and roof windows)
- Clear toughened glass (side and rear windows)
- Fully adjustable operator's seat and foot rest
- Cabin light
- Rig inclination indicator
- Rear view mirror
- 6 kg dry chemical fire extinguisher, type ABE class III
- 24 V outlet socket
- Fitted with speakers ready for CD, radio or DVD
- Electric combined engine/inclination/hole depth instrument display
- Adjustable foot rest
- Combined front mounted platform/tool box
- Air conditioning

Hole range and length (recommended)

Drill rig	Hole range
SmartROC C50	Ø 90-140 mm (3.5-5.5')
Hydraulic Rod Handling System for max hole length, 4.5 m (14' 9") COPROD sections	Thread (mm), COPROD sections
	CR 76, CR 89
	CR 102
	Hole length
	36 m (118')
	31.5 m (103.5')

Engine

CAT C9.3B, turbo charged diesel engine Tier 3/ EU Stage IIIA	Metric	US
Power rating at 1900 rpm	250 kW	340 hp
CAT C9.3B, turbo charged diesel engine Tier 4 Final /EU Stage 5 (EU/US cert)	Metric	US
Power rating at 1900 rpm	250 kW	340 hp

Compressor

Atlas Copco C146-07, screw type compressor	Metric	US
Working pressure, max	12 bar	174 psi
FAD at normal working pressure	223 l/s	472 cfm

Hydraulic system

Hydraulic oil cooler	Metric	US
Max ambient temperature	50°C	122°F

Pumps at 1900 rpm

Axial piston pump (1)	160 l/min	42.3 gal/min
Axial pump (2)	120 l/min	31.7 gal/min
Axial pump (3)	40 l/min	10.6 gal/min
Gear pump (4)	40 l/min	10.6 gal/min
Gear pump (5)	40 l/min	10.6 gal/min

Return and drainage filters

Filtration rate	10 µm absolute
-----------------	----------------

Volumes

	Metric	US
Hydraulic oil tank	100 l	36.4 gal
Hydraulic system, total	240 l	63.4 gal
Compressor oil	52 l	13.7 gal
Diesel engine oil	32 l	8.4 gal
Diesel engine, cooling water	75 l	19.8 gal
Diesel engine, fuel tank	400 l	105.7 gal
Traction gear	3 l	0.8 gal
Lubrication tank (ECL)	23 l	6.1 gal

Hydraulic rock drill

Rock drill	Drill rig	Impact power	Max hydraulic pressure	Max impact rate	Max torque	Approx. weight
COP 3060CR	SmartROC C50	30 kW (41 hp)	240 bar (3 481 psi)	50 hz	2 450 Nm (1 807 ibf/ft)	395 kg (871 lb)

Technical specifications

Selection of options

Carrier

- Track chains with triple grouser pads
- Hydraulic support leg
- Hydraulic winch including wire with towing eye and wire guides
- Heavy duty air intake filters for engine and compressor
- Protection rails on top of canopy
- Diesel driven engine heater
- Insulated and heated compressor regulation system
- Screw sampler device
- Extra LED work lights
- Electric fuel filling pump
- Fast fuel filling system

Safety cabin

- 10 mm clear laminated front / 8 mm laminated side / 8 mm toughened, clear or tinted
- 24 mm clear laminated front / 8 mm laminated side / 8 mm toughened, clear or tinted
- 10 mm tinted roof window
- Sun shade kit
- Window wiper, right hand side
- Radio/CD or Radio/DVD
- Combined warning sound and warning light - BEACON type
- Reverse camera with cab mounted monitor which can also be used for monitoring DVD

Feed

- Service winch with jib boom mounted on the feed
- Wide feed foot
- Thread lubrication, spray system
- Protective guard, according to EN16228

Water mist system

- Water mist system, water pump, one or two 400 l water tanks
- Artic-ready water mist system, water pump, one or two 400 l water tanks

Lubrication

- Central lubrication system, type Lincoln
- Artic hydraulic oil, VG 32
- Tropical hydraulic oil, VG 68
- Biological hydraulic oil, VG 46

Hole and inclination systems

- GPS compass aiming unit
- Laser plane receiver for hole depth
- Hole Navigation System

Automation & Software

- Measure while drilling
- Rig Remote Access
- Radio Remote Control (RRC)

Parts and Services products

- ROC Care
- COP Care

Optional accessories

- Gas charging equipment (for rock drill)
- First 50 hours service kit for compressor
- Lubrication kit
- RCS service tool box
- Electrical tool kit

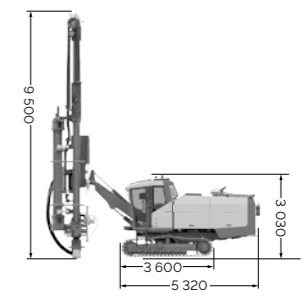
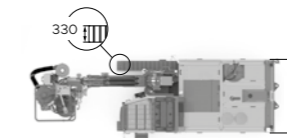
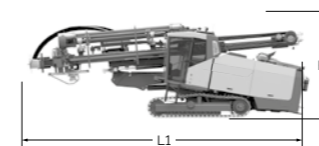

Height and length

Feed dumped	Metric	US
Height (H1)	3 500 mm	138'
Length (L1)	10 600 mm	417'

Weight

Standard unit excluding all options and COPROD sections	Metric	US
SmartROC C50	20 300 kg	44 800 lb

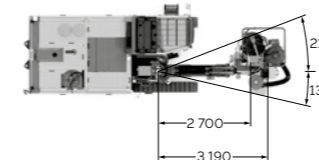

Horizontal reach (mm)

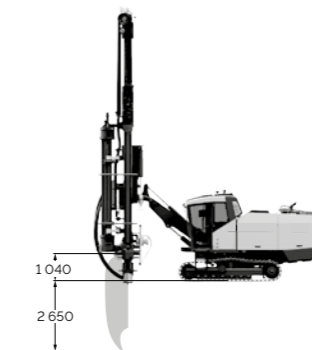

Vertical reach (mm)

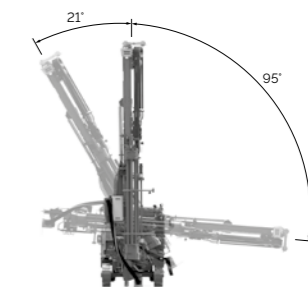

Feed swing angles



9868 0015 01c 2020-10 Örebro, Sweden. Legal Notice © Copyright 2020. Epiroc Rock Drills AB, Örebro, Sweden. All product names in this publication are trademarks of Epiroc. Any unauthorized use or copying of the contents or any part thereof is prohibited. Illustrations and photos may show equipment with optional extras. No warranty is made regarding specifications or otherwise. Specifications and equipment are subject to change without notice. Consult your Epiroc Customer Center for specific information.

United in performance. Inspired by innovation.

Performance unites us, innovation inspires us, and commitment drives us to keep moving forward. Count on Epiroc to deliver the solutions you need to succeed today and the technology to lead tomorrow.
epiroc.com

